

DIGITAL OUTPUT CARD DO-08

Varispeed SERIES OPTION CARD

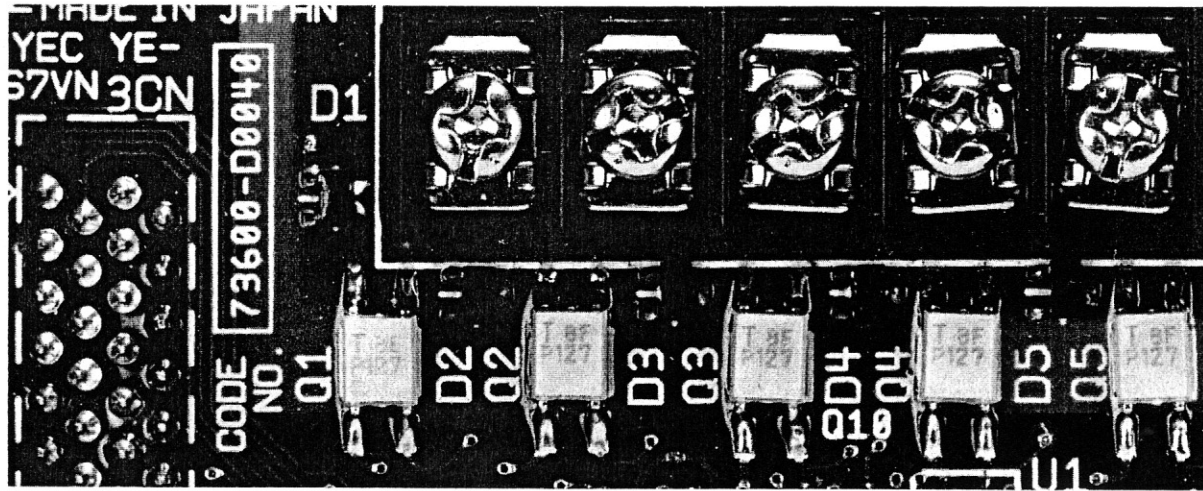

Before initial operation, read these instructions thoroughly, and retain for future reference.



YASKAWA

Digital output card DO-08, mounted on the inverter control PC board, is an on-board type option card which outputs insulation type digital signals in order to monitor inverter operation status (alarm signal, zero-speed detection, etc.).

This option card can be mounted on the following 4 series of inverters:

- VS-616G3 series · VS-616H3 series · VS-676VG3 series
- VS-676VH3 series

Name	Code No.	Output Method
Digital Output Card DO-08	73600-D004X	Photocoupler output : 6 channels (common) Relay contact output : 2 channels (independent)

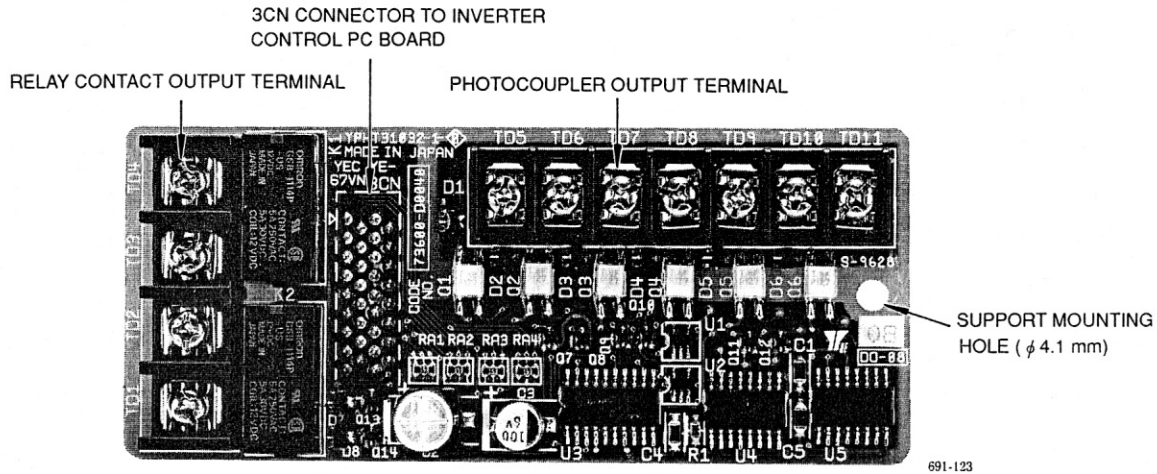

Digital Output Card DO-08

PRECAUTIONS

- (1) Before using digital output card DO-08, read this instruction manual thoroughly and that of the inverter on which the digital output card is to be mounted.
- (2) Before connection to the digital output card DO-08 connector or external terminals, turn off the inverter main circuit power supply and check that the inverter CHARGE indicator lamp has been extinguished.
- (3) Specify the name and code number when you order digital output card DO-08.

INVERTER INSTALLATION PROCEDURE (Fig. 1)

- (1) Turn off the main circuit power supply and remove the inverter faceplate. Then check that the inverter CHARGE indicator lamp has been extinguished.
- (2) Connect the digital output card DO-08 connector 3CN to connector 3CN(number of pins: 34 poles) on the inverter control PC board. At this time, insert the digital output card DO-08 support hole (one place) into the optioncard support on the control PC board until it clicks to fix digital output card DO-08.

Note: Do not mount digital output card DO-08 to any connector other than 3CN.

- (3) After mounting digital output card DO-08, connect the inverter to the peripheral devices. Then mount the inverter faceplate.

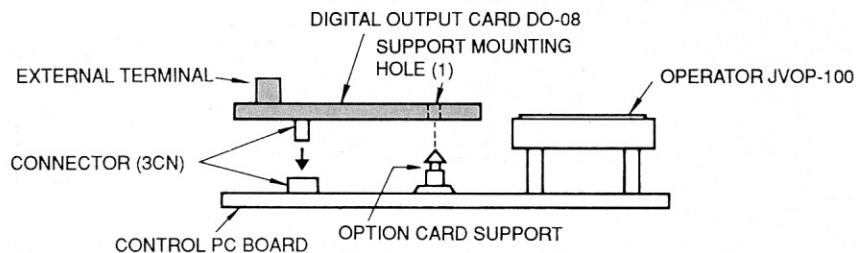
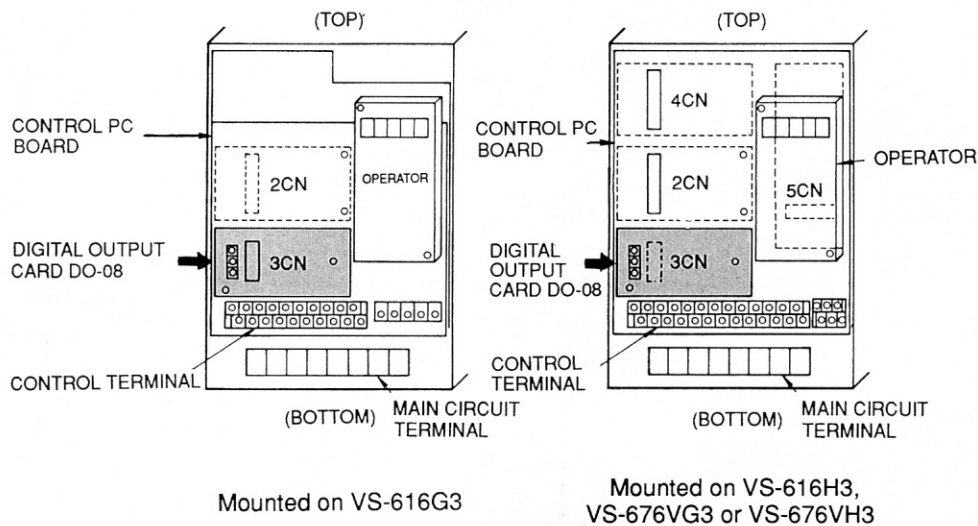

Sectional Diagram viewed from the Bottom

Fig. 1 Mounting of Digital Output Card DO-08

INTERCONNECTION BETWEEN DEVICES

Fig. 2 is an interconnection diagram of the inverter, digital output card DO-08 and peripheral devices. (The figure shows typical connection of digital output card DO-08 output with DC relay and AC relay.)

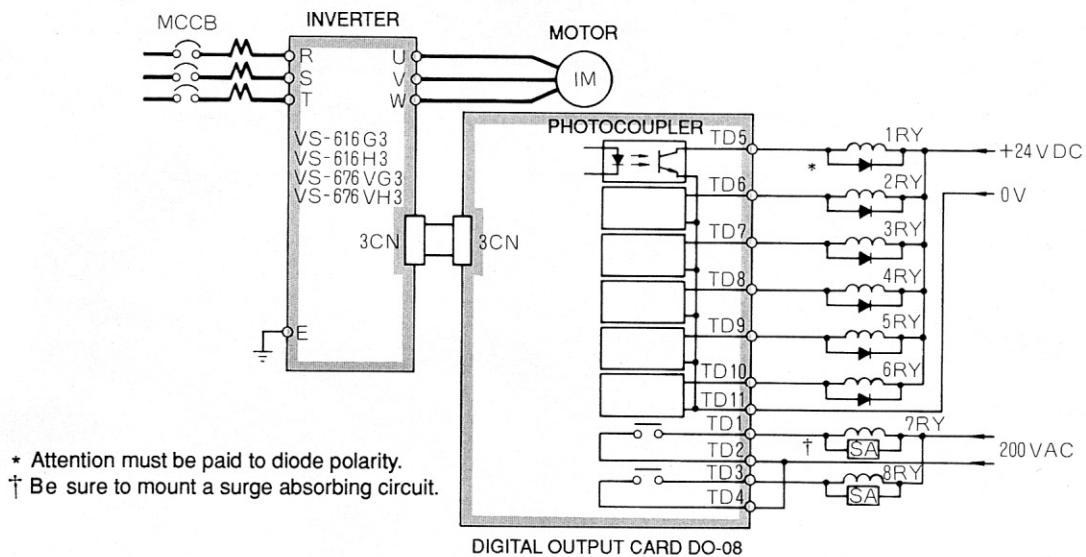

Fig. 2 Interconnection

WIRING PRECAUTIONS

- (1) Digital output card DO-08 control signal leads (terminals TD1 to TD11) must be separated from the main circuit leads and other power cables.
- (2) Use shielded lead for connection with sequencer, etc., and the ends of the lead must be prepared as shown in Fig. 3 in order to prevent erroneous operation caused by noise interference. Wiring distance must be 50 m or less.
- (3) Be sure to insert a surge absorbing circuit into the coil such as a relay, contactor or solenoid.

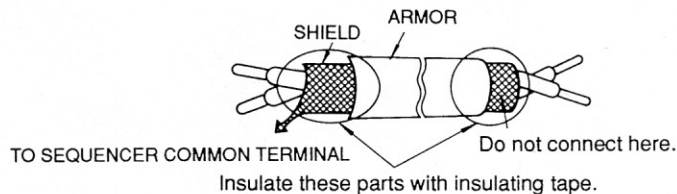

Fig. 3 Shielded Lead Termination

DESCRIPTION OF EXTERNAL TERMINAL FUNCTIONS

Digital output card DO-08 has external terminals (11 poles) to connect with peripheral devices. Table 1 shows the terminal functions.

Table 1 Digital Output Card DO-08 Terminal Functions

Terminal No.	Terminal Screw Size	Function	Specifications	Output Contents*
TD1 to TD4	M3	Relay contact output : 2 outputs (independent)	Applied voltage/current 250 VAC 1 A or less 30 VDC 1 A or less	Refer to "OUTPUT CONTENTS OF EXTERNAL TERMINALS."
TD5 to TD11		Photocoupler output : 6 outputs (common, common) terminal TD11	Applied voltage/current 48 V 50 mA or less	

Note : The output contents of TD1 to TD11 can be selected by setting inverter program constant (Sn-27). Refer to "OUTPUT CONTENTS OF EXTERNAL TERMINALS."

OUTPUT CONTENTS OF EXTERNAL TERMINALS

The digital output card DO-08 output contents can be selected by setting inverter program constant. Table 2 shows the setting constant and output contents to be selected.

Table 2 Digital Output Card DO-08 Output Contents

Program Constant No.	Set Value	Output Contents	Factory Setting
Sn-27 First Digit 	0	Output signal combination 1 (output data : fixed) Refer to Table 3.	× × × 0
	1	Output signal combination 2 (coded output) Refer to Table 4.	

Table 3 Output Contents of Output Signal Combination 1

Terminal No.	Output Contents
TD5-TD11	Overcurrent (OC)
TD6-TD11	Overvoltage (OV)
TD7-TD11	Inverter overload (OL2)
TD8-TD11	Fuse blown (FU)
TD9-TD11	Overspeed (OS)*
TD10-TD11	Inverter overheat (OH)
TD1-TD2	Zero-speed detecting (ZSP)
TD3-TD4	Speed agree (AGREE)

Table 4 Output Contents of Output Signal Combination 2

Terminal No.	Output Contents	
TD5-TD11	Coded output Refer to Table 5.	Bit 0
TD6-TD11		Bit 1
TD7-TD11		Bit 2
TD8-TD11		Bit 3
TD9-TD11	Zero-speed detecting (ZSP)	
TD10-TD11	Speed agree (AGREE)	
TD1-TD2	Running (RUN)	
TD3-TD4	Minor fault (ALM)	

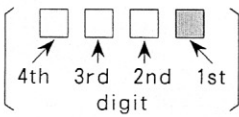
Note : TD11 is a common terminal.
* Not used in VS-616G3.

Table 5 Coded Output Contents

Bit 3 to 0	Output Contents (Coded Output)	Bit 3 to 0	Output Contents (Coded Output)
0000	No fault	1000	External fault (EFxx)
0001	Overcurrent (OC) (including grounding)	1001	Inverter hardware fault (CPFxx)
0010	Overvoltage (OV)	1010	Motor overload (OL1)
0011	Inverter overload (OL2)	1011	Not used
0100	Inverter overheat (OH)	1100	Power loss (UV) (including momentary power loss)
0101	Overspeed (OS)*	1101	Excessive speed deviation (DEV)*
0110	Fuse blown (FU)	1110	PG disconnection (PG)*
0111	Not used	1111	Cooling fan fault (FAN)*

* Not used in VS-616G3.

(Example) Typical Coded Output

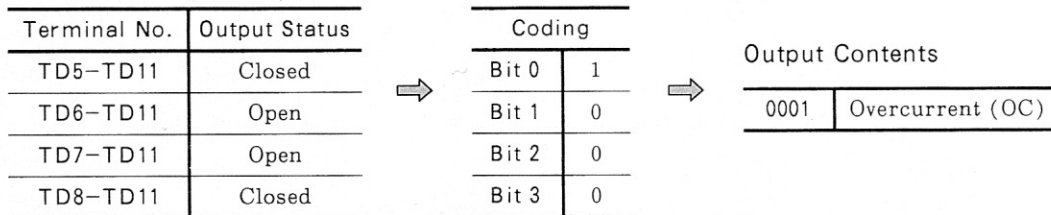

MEMO